



# E-bike

Flying Fish



# E-SCOOTER

Smart electric scooter



[www.hx1000.com](http://www.hx1000.com)



# COMPANY PROFILE

## ★ Shenzhen Huanxi Technology Co.,Ltd.

Was established in Jan.,2013,we are professional manufacturer for intelligent mobility vehicle. There are over 200 staff in Shenzhen Special Economic Zone, specialized product Teaching and Research base of Shenzhen Research institute of Xiamen University.

HX is a global smart technology brand from living inspiration,which belongs to Shenzhen Huanxi Technology Co.,Ltd. We specialize in smart electric mobility products. HX has a group of creative, passionate design team, who are from Germany, the US, China and other countries with many years of world-renowned brand design and manufacturing experience.

We welcome long term cooperation for OEM service. Contact us today.

## CERTIFICATION



14 Years Factory for Mobility Scooter with BSCI & ISO  
Product is CE approved by SGS Lab

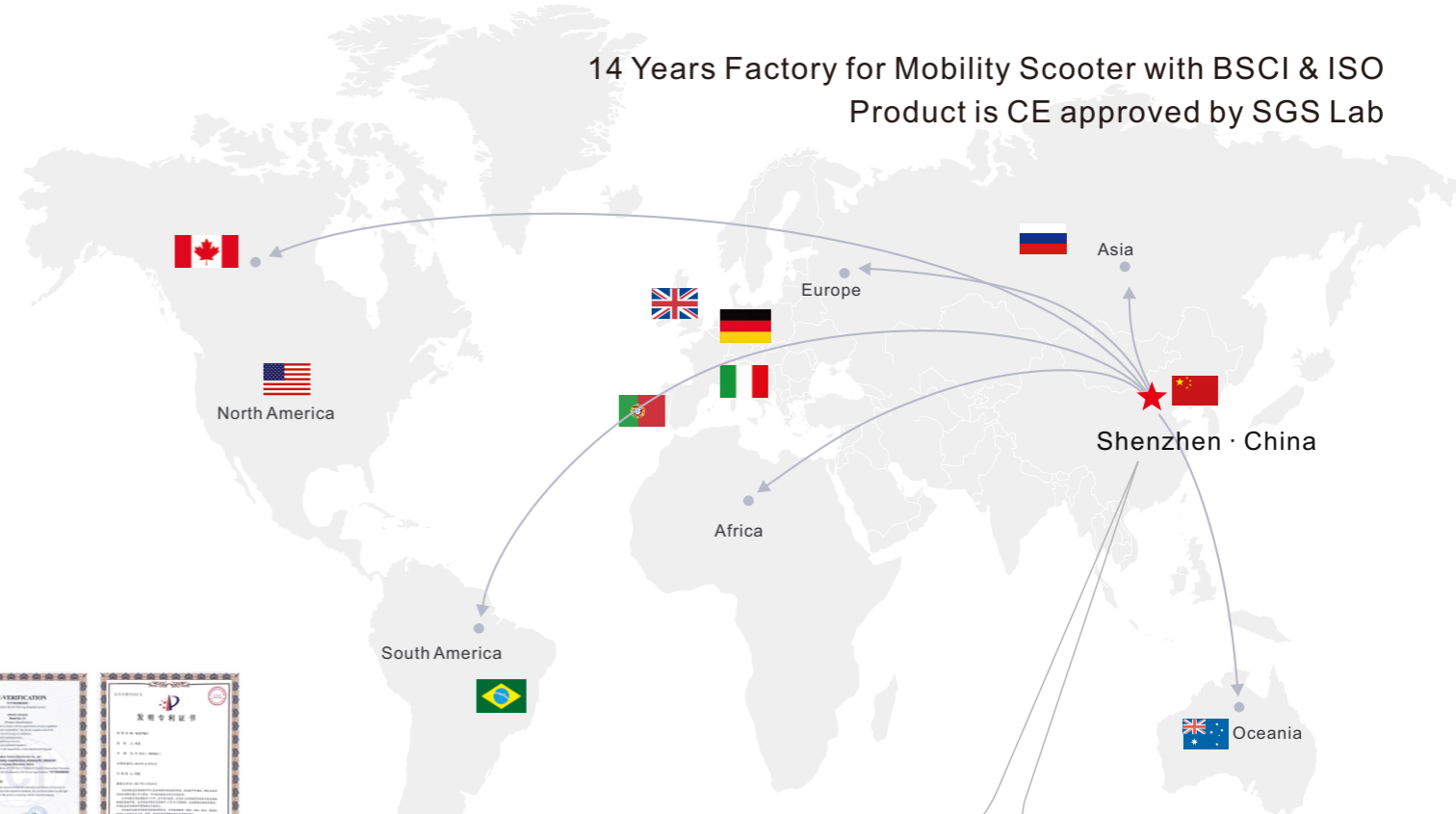

**Shenzhen Huanxi Technology co.,Ltd**  
Address: 4/F,Makerspace,Hualian Industrial Park,Huaning Road, Dalang street,Longhua District,Shenzhen,China

# MILESTONES



HX brand was officially founded-Intelligent transportation brand!

Products have passed ISO9001, CE, FCC, ROHS and other relevant international quality certification authority.

HX smart drifting scooter **X1** was launched, which was applied smart drifting technology. The stability is much better than similar products!

HX brand **X3** New design model launched.

Dragonfly Design **X6** E-scooter New listing, HX smart drifting scooter **X2** was launched

HX-**X7** off-road Air wheel folding Scooter New listing

Start the great business of **X6** and **X7** folding e-scooter

HX-**X8** Smart Electric Scooter New listing

HX-**H1** Flying Fish Micro E-Bike H1 New listing

June

October

May

April

March

September

January

October

September

2013

2014

2015

2016

2017

2018

2019

2019

2020



New product  
Worth waiting

X9

# FACTORY TOURING



# H1 E-bike

1. Fingerprint unlock design, patent private mold
2. Automatic induction, light the lamp according to the light intensity.
3. Bionic flying fish shape, Avant-garde design
4. Removable battery, longer range by riding
5. Double disc braking system, high efficiency braking
6. Shock spring design, comfortable riding

<b>25</b> km/h	<b>55</b> km	<b>250</b> W
Max Speed	Max. Range	Motor

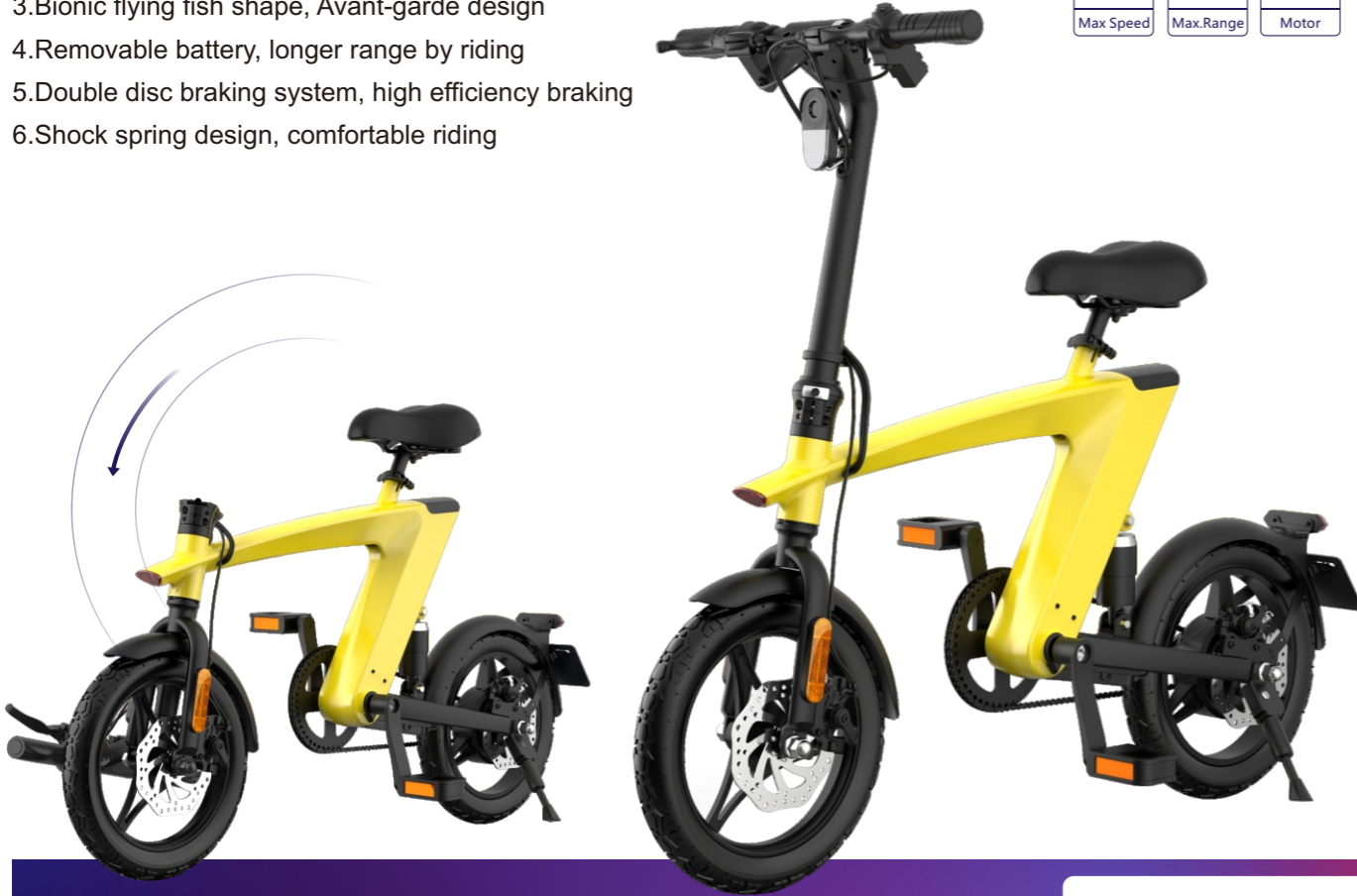

Patent No. ZL2019 3 0488643 .9

Color

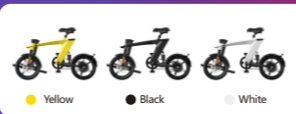

Item.	Flying Fish Micro E-Bike H1
Open Size	1178x450x1022mm
Folding Size	1178x350x760mm
Pedal shaft height above ground	250mm
Frame Materials	Aluminium Alloy
Net Weight	18kg
Hight from the lowest point of the pedal to the ground	60mm
Wheel Size	14 inch
Ride Mode	Riding / Electric
Color	Black / White / Yellow
Motor Parameters	36V/250W
Battery Capacity	36V/10AH
Power Adapter	42V/2A
Max. Speed	25km/h
Pure Electric Range	25-35km
Riding Max. Range	45-55km
Climb Angle	15°
Max. Load	100kg
Charging Time	5-6h
Folding Function	Poling folding
Seat height	Liftable
Battery Removal Function	Plug type with mechanical lock
Damping mechanism	Rear spring shock absorber
Brake Mode	Front and rear double disc brakes
Accelerate	3 gears, linear speed
Alarm method	Electronic horn
Diversion	Left and right turn signals
Flashlight	LED
Rear warning	Warning light
APP	Optional
USB Power Bank	Optional

## Packaging accessories

E-BIKE	x1	Charging adapter	x1	User's Guide	x1
--------	----	------------------	----	--------------	----

# X8 E-SCOOTER

1. First development embedded battery, patented design.
2. 40 lithium battery cells combinations, long riding range.
3. Strong power motor, instant acceleration secondly.
4. 3 second fast folding, pleasant experience.
5. Triple brake system, high efficiency brake.
6. Three speed modes can be switched easily.

25 km/h	45 km	350w
Max Speed	Max.Range	Motor



Color

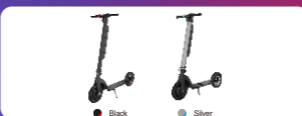

Patent No. ZL 201930026681.2

Item.

X8 Off-road Air wheel folding Scooter

8.5 inch

10 inch

	8.5 inch	10 inch
Max.Range	30-45km	30-45km
Max.Speed	25km/h	25km/h
Max.Load	100Kg	100Kg
Flashlight	LED highlight front light	LED highlight front light
Folding method	One step folding	One step folding
Charging time	5-6h	5-6h
Charger parameters	DC42V/2A	DC42V/2A
Motor	250W/350w Optional	250W/350w Optional
Battery Capacity	7.8Ah/10Ah/12.8Ah Optional DC36V	7.8Ah/10Ah/12.8Ah Optional DC36V
Tire size	8.5 inch Vacuum tire	10 inch Vacuum tire
Way of battery	Self locking	Self locking
Display screen	LED	LED
Climb Angle	15°	15°
Frame material	Aviation aluminum alloy	Aviation aluminum alloy
Net weight	14.5kg	15kg
Gross weight	16.5kg	17kg
Folding size	1073x401x450mm	1083x401x460mm
Open size	1073x401x1176mm	1083x401x1186mm

## Packaging accessories

E-SCOOTER	x1	Charging adapter	x1	User's Guide	x1
-----------	----	------------------	----	--------------	----

# X7 E-SCOOTER

1. Waterproof level IP54
2. LCD display
3. LED flashlight
4. One step folding
5. Pneumatic tire
6. Removeable battery box
7. Double Brake System

<b>25</b> km/h	<b>20</b> km	<b>350</b> w
Max Speed	Max.Range	Motor



Removeable battery box

## Color

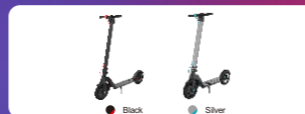

Patent No. ZL 201720370768.7

Item.	X7 Off-road Air wheel folding Scooter	
	8.5 inch	10 inch
Max.Range	20km	20km
Max.Speed	25km/h	25km/h
Max.Load	100Kg	100Kg
Flashlight	LED highlight front light	LED highlight front light
Folding method	One step folding	One step folding
Charging time	2-3h	2-3h
Charger parameters	DC42V/2A	DC42V/2A
Motor	250W/350w Optional	250W/350w Optional
Battery Capacity	5Ah/6.4Ah Optional DC36V	5Ah/6.4Ah Optional DC36V
Tire size	8.5 inch Vacuum tire	10 inch Vacuum tire
Way of battery	Self locking	Self locking
Display screen	LCD	LCD
Climb Angle	15°	15°
Frame material	Aviation aluminum alloy	Aviation aluminum alloy
Net weight	12.5kg	13kg
Gross weight	14kg	15kg
Folding size	1056x401x450mm	1083x401x460mm
Open size	1056x401x1166mm	1083x401x1186mm

## Packaging accessories

E-SCOOTER	x1	Charging adapter	x1	User's Guide	x1
-----------	----	------------------	----	--------------	----

# X6L E-SCOOTER

1. With 13 patents, Patent Protection.
2. Detachable & Replaceable battery.
3. Quadruple folding E-scooter ,Smallest Size in the market , easy for carrying,Save shipping freight.
4. Suspension on the front wheels,Shock Absorber.
5. Bluetooth Speaker.
6. Accessory bag for easy store and carrying.

25 km/h

Max Speed

15 km

Max.Range

250w

Motor



Removeable battery box

Patent No. ZL 201730421916.9

Item.

X6L Backpack E-scooter

Max.Range	15km
Max.Speed	25km/h
Max.Load	20-100Kg
Flashlight	LED
Folding method	Quadruple folding
Way of battery	Self locking
Battery Capacity	DC25.2V / 6Ah/7.8Ah Optional
Tire size	5.5inch
Bluetooth speaker	4 Ω 3W
Display screen	LCD
Charger parameters	DC29.4V/2A
Motor	250W
Climb Angle	10°
USB charger	5V/2A Output
Net weight	10kg
Gross weight	12kg
Applicable height	20-180cm
Max.Load	20-100kg
Open size	920*475*1070mm
Folding size	675*130*305mm

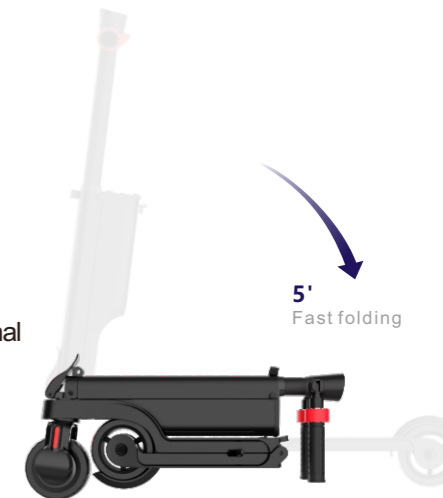

## Packaging accessories

E-SCOOTER	x1	Charging adapter	x1	User's Guide	x1
-----------	----	------------------	----	--------------	----



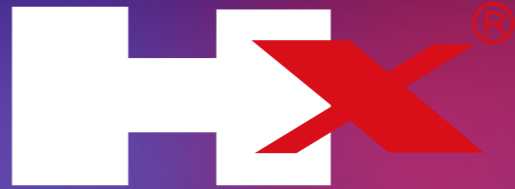

Shenzhen Huanxi Technology co.,ltd